

February 2010

# alphabeds of Dolbantau Mill

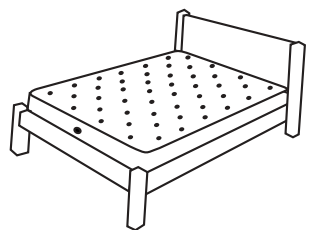

Pine beds ♦ Beech beds ♦ Mattresses  
All made in our West Wales workshop

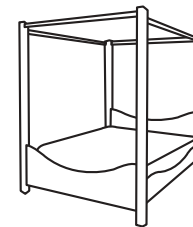
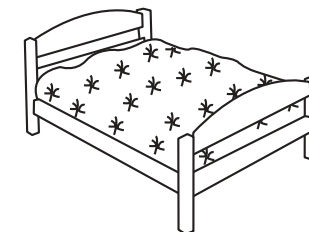

**Self assembly solid wood beds in all standard and custom sizes.  
A choice of natural seal or over one hundred colour finishes.**

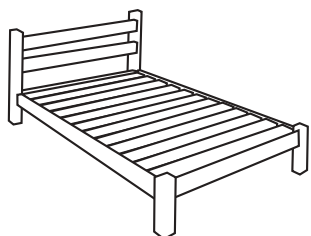

- Size changing cot/bed
- Day beds & Extending sofa - bed
- Futons
- Full range of mattresses:  
Spring interior, Pocket spring or Metal free.  
Natural and **Organic** fillings.
- Extra long beds
- Extra wide beds
- Bunk beds
- High platform beds
- Child sized beds
- Four Poster beds

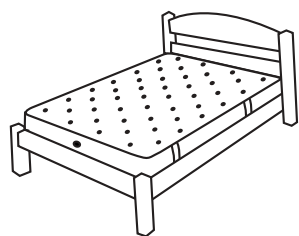
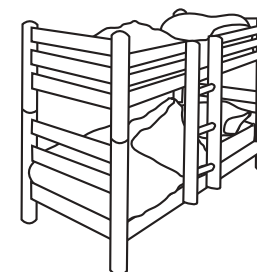

Head Office and Workshop/Retail Outlet,  
Dolbantau Mill, Llanfihangel-Ar-Arth,  
Pencader, Carmarthenshire.SA39 9JD.  
Mon.-Thurs.. 09.00-17.00hrs. Fri. 10.00-16.00hrs. .  
Tel: 01559 395 428 fax: 01559 395 496  
E mail- enquiries@alphabeds.co.uk

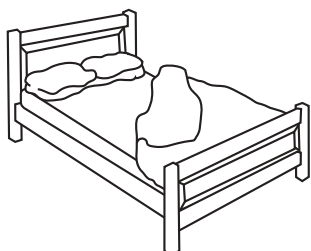

## www.alphabeds.co.uk

# alphabeds Workshop and technical information

Monday - Thursday 9am - 5pm

Friday - 10am - 4pm

01559 395 428 or e-mail: [enquiries@alphabeds.co.uk](mailto:enquiries@alphabeds.co.uk)

## Delivery Charges

Inside M25.....£25.

Country wide (mainland only) from £30

Assemblies from £25

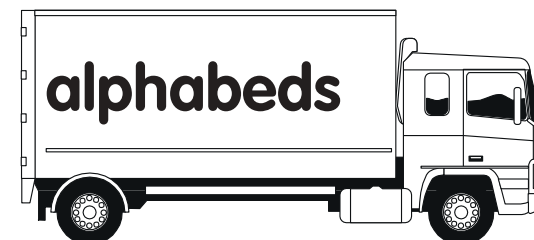

Subject to size of order. Some mattresses are not suitable for countrywide delivery, please check.

**For delivery** phone credit card details **or** send cheque with order (made payable to 'alphabeds' and crossed) to Alphabeds, Dolbantau Mill, Llanfihangel-Ar-Arth, Pencader. SA39 9JD.

Orders are sent as soon as possible by overnight carrier. It is possible to specify a day (Tuesday to Friday) for delivery, though not an exact time. If you wish to have delivery on a specific day, please give notice in your order. **PLEASE CHECK YOUR GOODS ON RECEIPT BEFORE SIGNING.**

---

---

## All prices inclusive of VAT @ 17.5%

In order to comply with the British & European Standards, designs are subject to detail change without notice.

---

---

## alphabeds standard Mattress Sizes

Small single	2'6" x 6'3"	(76.2 x 190.5cm)
Child's single	2'6" x 5'5" / 5'6"	(76.2 x 152.4/167.64cm)
<b>Standard single</b>	<b>3' x 6'3"</b>	(91.44 x 190.5cm)
Large single	3'6" x 6'3"	(106.68 x 190.5cm)
Small double	4' x 6'3"	(121.92 x 190.5cm)
<b>Standard double</b>	<b>4'6" x 6'3"</b>	(137.16 x 190.5cm)
<b>Standard King Size</b> (American Queen Size)	<b>5' x 6'6"</b>	(152.4 x 198.12cm)
Large King Size	5'6" x 6'6"	(167.64 x 198.12cm)
<b>Superking</b> (American King Size)	6' x 6'6"	(182.88 x 198.12cm)

\* **For overall frame measurements add:**

**5" to length (12.5cm)**

**1 3/4" to width (4.5cm) Most frames.**

**3" to width (7.6cm) Daybed/Stacker/Fourposter and beds with double-depth siderails.**

# Frame Construction

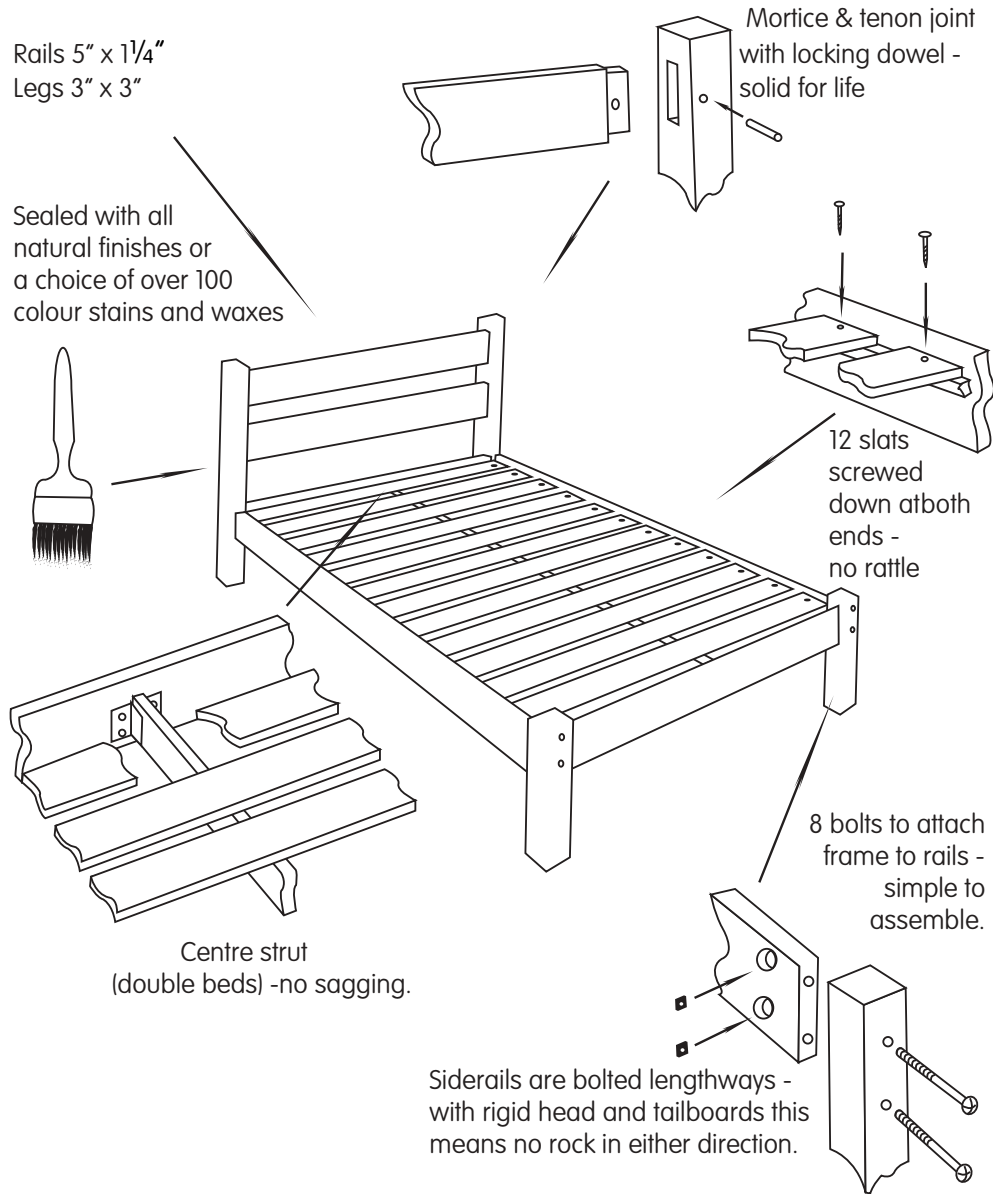

# Assembly

Beds are supplied in kit form for home assembly. All you need is a phillips and a flat blade screwdriver.  
*Instructions and fittings supplied.*

An assembly service is available (depending on area). Please check with shop for details.

# Underbed Storage

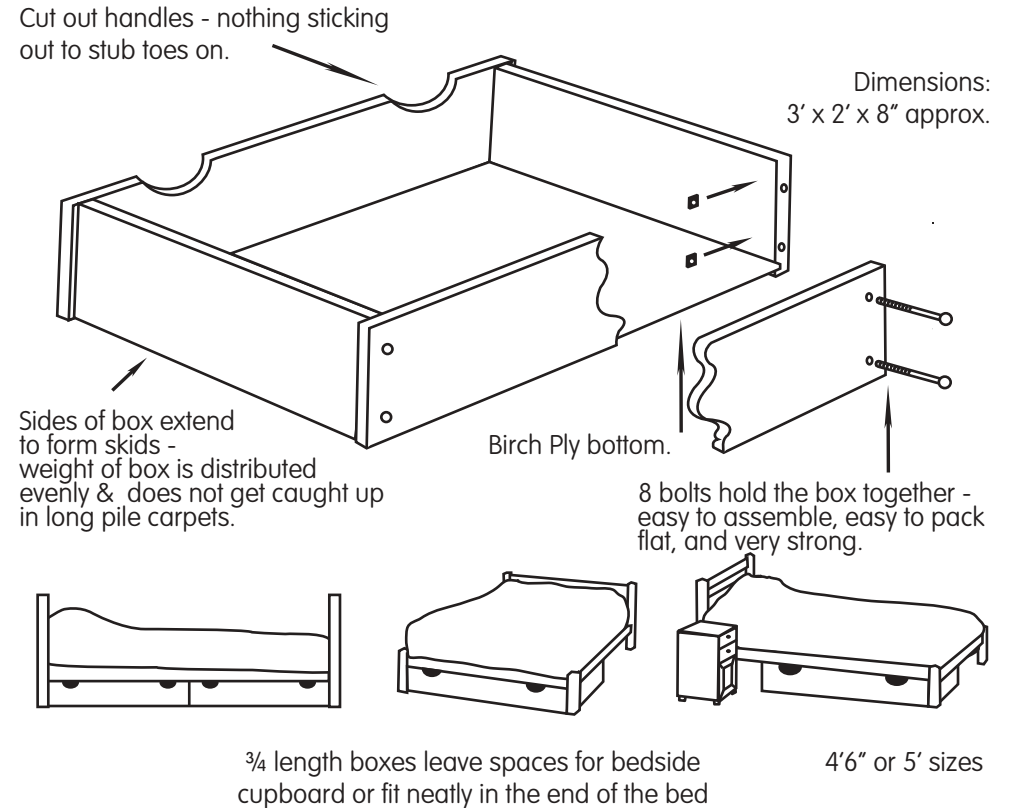

**A** Basic frame without headboard (leg height 14")

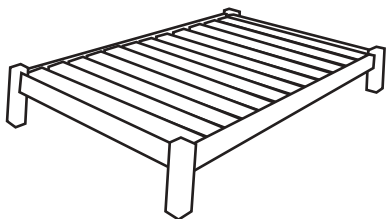

	Pine	Beech	Colour
2'6"/3'x6'3"	£127	£204	+£25
3'6"x6'3"	£170	£237	+£25
4'4'6"x6'3"	£187	£275	+£30
5'x6'6"	£226	£325	+£30
5'6"x6'6"	£303	£385	+£35
6'x6'6"	£352	£435	+£35

**B** Single bar headboard: enough to keep pillows in place (leg height 25" & 14")



	Pine	Beech	Colour
2'6"/3'x6'3"	£176	£250	+£25
3'6"x6'3"	£198	£297	+£30
4'4'6"x6'3"	£236	£336	+£30
5'x6'6"	£297	£385	+£35
5'6"x6'6"	£358	£479	+£40
6'x6'6"	£413	£500	+£40

**D** Doublebar headboard high enough to lean against (leg height 33" & 14")

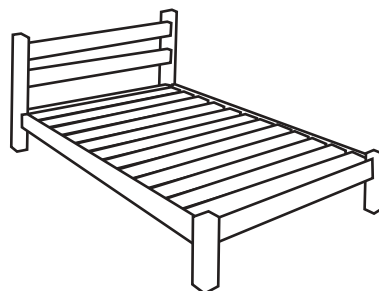

	Pine	Beech	Colour
2'6"/3'x6'3"	£193	£297	+£30
3'6"x6'3"	£226	£330	+£30
4'4'6"x6'3"	£280	£374	+£40
5'x6'6"	£341	£435	+£40
5'6"x6'6"	£397	£495	+£45
6'x6'6"	£446	£545	+£50

**D/s** One piece panel on headend (leg height 33" & 14")

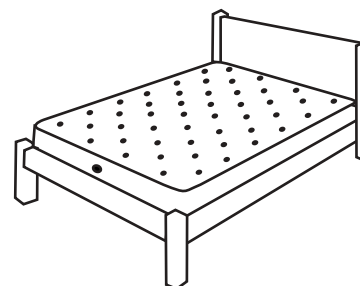

	Pine	Beech	Colour
2'6"/3'x6'3"	£253	£363	+£35
3'6"x6'3"	£292	£424	+£35
4'4'6"x6'3"	£347	£495	+£40
5'x6'6"	£385	£572	+£45
5'6"x6'6"	£468	£710	+£50
6'x6'6"	£506	£737	+£55

**DB/s** Panel at head and tail (leg height 33" & 22 1/2")

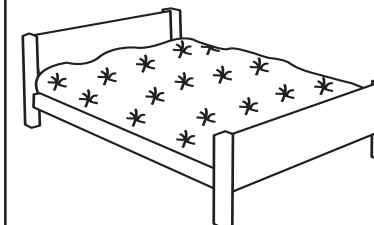

	Pine	Beech	Colour
2'6"/3'x6'3"	£275	£402	+£40
3'6"x6'3"	£319	£462	+£40
4'4'6"x6'3"	£385	£545	+£45
5'x6'6"	£435	£665	+£50
5'6"x6'6"	£495	£825	+£55
6'x6'6"	£567	£858	+£55

**E** As 'D' with deeper arched top bar (leg height 33" & 14")

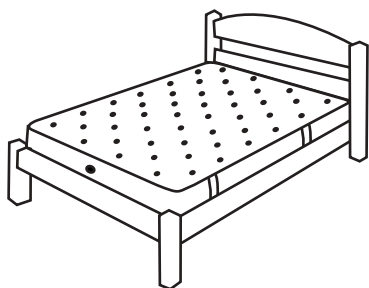

	Pine	Beech	Colour
2'6"/3'x6'3"	£209	£325	+£30
3'6"x6'3"	£253	£358	+£30
4'4'6"x6'3"	£303	£396	+£40
5'x6'6"	£352	£446	+£40
5'6"x6'6"	£418	£506	+£45
6'x6'6"	£484	£567	+£50

**F** Arched bar at head and foot (leg height 33" & 25")

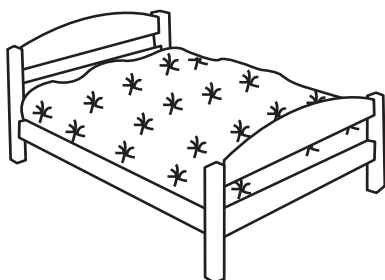

	Pine	Beech	Colour
2'6"/3'x6'3"	£264	£402	+£35
3'6"x6'3"	£330	£462	+£35
4'4'6"x6'3"	£385	£545	+£40
5'x6'6"	£435	£665	+£45
5'6"x6'6"	£495	£825	+£50
6'x6'6"	£567	£858	+£55

**E/s** Solid arc headboard (leg height 33" & 14")

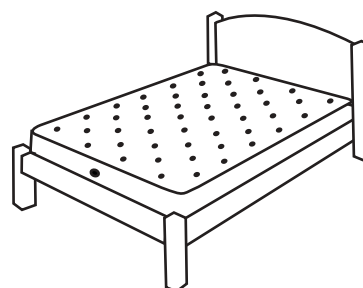

	Pine	Beech	Colour
2'6"/3'x6'3"	£270	£390	+£35
3'6"x6'3"	£319	£446	+£40
4'4'6"x6'3"	£363	£534	+£40
5'x6'6"	£413	£594	+£45
5'6"x6'6"	£506	£787	+£50
6'x6'6"	£545	£825	+£55

**F/s** Solid arc head and footend (leg height 33" & 22 1/2")

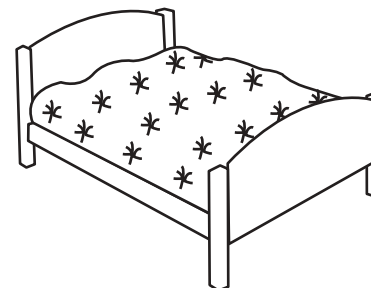

	Pine	Beech	Colour
2'6"/3'x6'3"	£303	£440	+£40
3'6"x6'3"	£347	£495	+£40
4'4'6"x6'3"	£413	£583	+£45
5'x6'6"	£462	£688	+£50
5'6"x6'6"	£599	£885	+£55
6'x6'6"	£627	£935	+£55

**G** Bunk beds separate into two singles (overall height 62")  
Different ladder positions available.

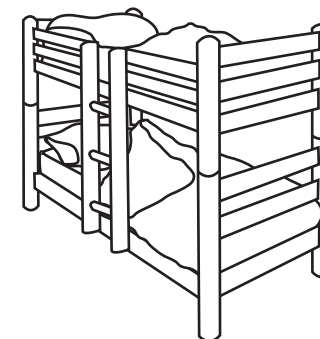

	Pine	Beech	Colour
2'6"/3'x6'3"	£545	£732	+£80

Wider / longer possible on application

**H** Inset fielded panel at head & tail (leg height 38" & 25")

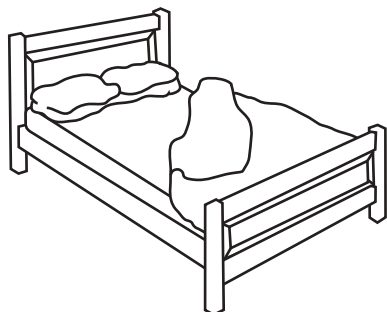

	Pine	Beech	Colour
2'6"/3'x6'3"	£330	£500	+£45
3'6"x6'3"	£374	£599	+£45
4'/4'6"x6'3"	£424	£665	+£55
5'x6'6"	£512	£737	+£55
5'6"x6'6"	£616	£968	+£65
6'x6'6"	£665	£1025	+£65

**J** Scalloped head & tail board (18" deep) with rounded leg top & rail (leg ht. 40" & 28 1/4")

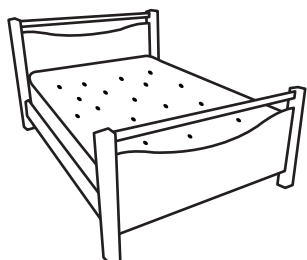

	Pine	Beech	Colour
2'6"/3'x6'3"	£330	£500	+£45
3'6"x6'3"	£374	£599	+£45
4'/4'6"x6'3"	£424	£665	+£55
5'x6'6"	£512	£737	+£55
5'6"x6'6"	£616	£968	+£65
6'x6'6"	£665	£1025	+£65

**K** Four poster approx. 6'6" high Double depth siderails for stability. Round top rails will take standard wooden curtain rings



	Pine	Colour
2'6"/3'x6'3"	£450	+£55
3'6"x6'3"	£495	+£60
4'/4'6"x6'3"	£605	+£70
5'x6'6"	£665	+£75
5'6"x6'6"	£787	+£80
6'x6'6"	£847	+£85

**L** High Bed maximum clearance underneath 5'3"

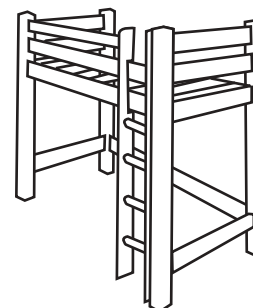

	Pine	Colour
2'6"/3'x6'3"	£506	+£55
3'6"x6'3"	£556	+£60
4'/4'6"x6'3"	£616	+£70
5'x6'6"	£665	+£75
5'6"x6'6"	£809	+£80
6'x6'6"	£847	+£85

**N** Dowelled head & tail (leg height 40" & 29")

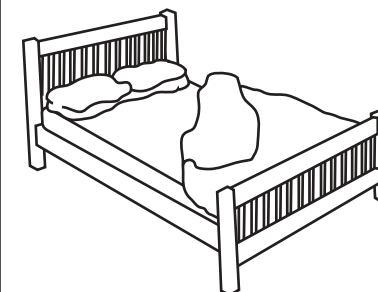

	Pine	Beech	Colour
2'6"/3'x6'3"	£314	£495	+£45
3'6"x6'3"	£358	£539	+£45
4'/4'6"x6'3"	£429	£633	+£55
5'x6'6"	£495	£710	+£60
5'6"x6'6"	£605	£814	+£65
6'x6'6"	£633	£858	+£75

## Over 100 colour stains and colour waxes to choose from

### Extras

#### Underbed storage boxes

	Pine	Beech	Colour
3' x2'	£45	£65	+£10
4'6"x2'	£65	£90	+£10
5' x2'	£70	£95	+£10

#### Screw-on safety rails

	£25	£35	+£5
--	-----	-----	-----

#### Custom Widths

Ring for details/quotes.

#### Additional slats

3' -	£2.00 (each)
4'6" -	£2.50 (each)
5' and over -	£3.00 (each)

#### Increased leg height

Maximum height under siderail: 15"  
(for any frame which has a head and/ or footend with only one bar e.g. B frame)

Pine	Beech
£30	£40

Maximum height under siderail: 24"  
(for other frames)

£40	£55
-----	-----

For legs over 24" please enquire.

#### Lengths other than

5', 5'6", 6', 6'3", 6'6".

£20	£25
-----	-----

#### Ball ended legs

Head only  
Head & Foot

£30	£50
£60	£80

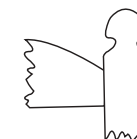
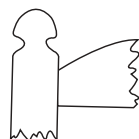

## Extending cot and organic mattress

*Converts into a full length bed.*

	Pine	Colour*	Beech
Cot/bed (Frame only)	£285	£325	£450
Cot/bed and <b>Organic</b> mattress	£370	£410	£535

**Organic** mattress (2'6" x 4') £95

**Organic** mattress for British Standard Cot (23" x 47") £95

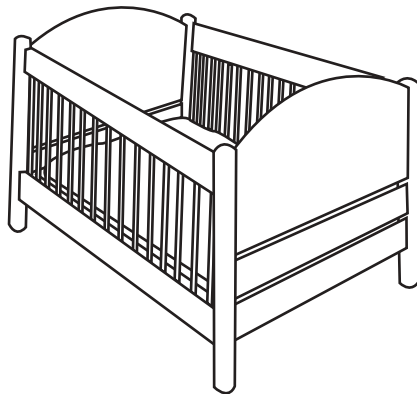

Our 2'6" x 4' fixed sided cot can be supplied with a set of 5', 5'6" or 6'3" side rails (available at £30) so that it can be converted later into a single or child size bed. These can be purchased at a later date. (mattress not included).

The 2'6" x 4' cot mattress is made using only natural materials. A coir/latex pad is covered with **organic** lambswool and topped with an **organic** cotton cover. The combination of lambswool and cotton allows this mattress to conform to BS7177 (fire safety regs) without chemical treatment.

	Pine	Colour	Beech
Storage box (approx 4' x 2' x 8")	£55	£65	£80

\* **Some colour finishes are not suitable for cots - check with sales personnel**

## Extending A frame

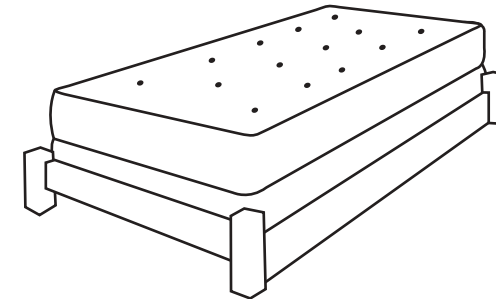

2'6" x 6'3" opening to 5' x 6'3" (mattress size)  
Overall length 6'8", width 2'10½" to 5'3"  
Frame only £300

or

3' x 6'3" opening to 6' x 6'3" (mattress size)  
Overall length 6'8", width 3'4½" to 6'3"  
Frame only £357

*(For mattress see back of price list)*

*Mattress covers available from £35 each - see Daybed.*

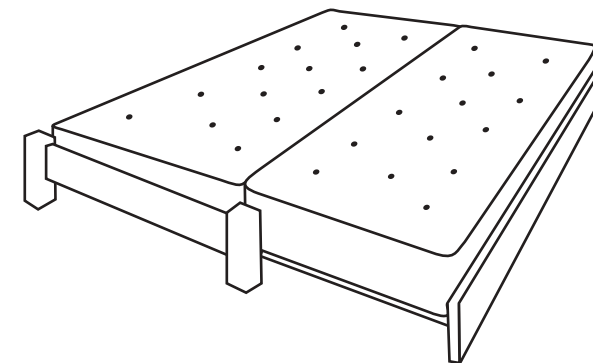

## Extending Sofa Bed

2'6" x 6'3" extending to 5' x 6'3" (mattress size)  
 Maximum overall length 6'8"  
 depth 2'10½" to 5'3"  
 height 2'11"

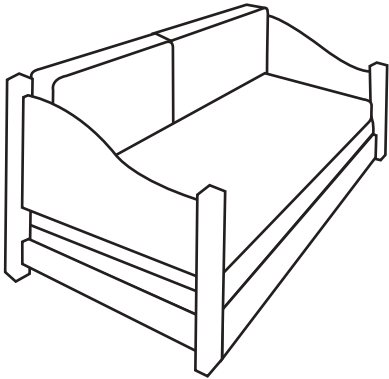

Frame only (pine)	2'6" / 3' wide	£400/£425
Any colour finish		£ 50
Two Sofabed mattresses		£240 a pair.
Mattress covers (x2) (plain)		£ 70
Mattress covers (x2) (embossed)		£ 90
Two solid back cushions		£ 70 a pair
Two solid back cushion covers (plain)		£ 50 a pair
Two solid back cushion covers (embossed)		£ 60 a pair

*for other cushions, see Daybed.  
 easy slide deployment*

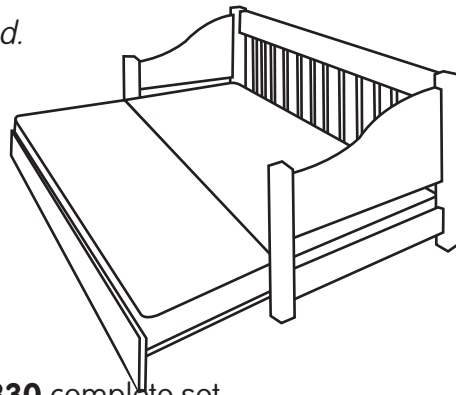

**Pine frame + plain covers £830** complete set.  
**Coloured stained frame + embossed covers £910**

## Daybed

2'6" or 3' x 6'3" (mattress size)  
 Overall length 6'8", depth 2'9" or 3'3", height 2'9"

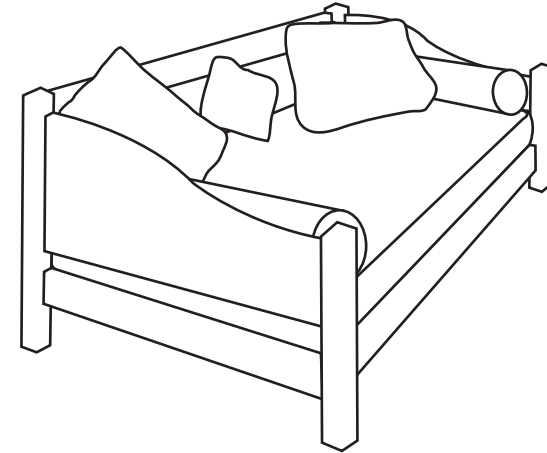

Frame only (pine)	£325
Any colour finish	£ 35
Daybed mattress	£120
Mattress cover (plain)	£ 35
Mattress cover (embossed)	£ 45
Cushions	£ 20(lge) £15 (med) £10 (sml)
Cushion cover (plain)	£ 15(lge) £12 (med) £10 (sml)
Cushion cover (embossed)	£ 20(lge) £15 (med) £13 (sml)
Bolsters	£ 40(lge) £25 (sml)
Bolster covers (plain)	£ 25(lge) £15 (sml)
Bolster covers (embossed)	£ 30(lge) £20 (sml)

**Pine frame + plain covers £707** (+mattress/bolster set/1 small, 1 med. and 1 large cushion)

**Colour stained frame + embossed covers £778** (+mattress/bolster set/ 1 small, 1 med. and 1 large cushion)

# Mattresses

Here are some brief notes to guide you around the **alphabeds** range. More details can be obtained from the sales staff; by calling the office on 01559 395 428 or by looking on the website at [www.alphabeds.co.uk](http://www.alphabeds.co.uk).

Mattresses as well as bedframes can be made to non-standard sizes.

All mattresses are individually made and hand tufted.

All mattresses consist of a **core** with one or more layers of **fillings** and an outer **cover**

## Core types

**Open Spring** : Traditional mattress interior made with around 300 (4'6" x 6'3") hourglass shaped springs.

**Pocket Spring**: High quality mattress interior with over 1000 springs (5'x6'6") each in its own cloth bag or pocket.

**Solid Core**: Latex (Natural rubber-No polyurethanes used) or latex/coir matrix. An all natural alternative to springs.

**Futon Style**: Made from layers of cotton and wool

## Fillings

**Cotton**: Exactly like cotton wool but made from heavier fibres for longer life. 'Needled' cotton is compressed and strong, 'layered' cotton is light and fluffy. ( Cotton can contain a small amount of man-made fibre for binding purposes )

**Polyester**: Very warm and springy man made fibre. Long lasting and lightweight.

**Pure New Wool**: The words 'Pure New Wool' must be used to describe the filling used by **alphabeds**. The wool used by **alphabeds** is not only 100% Pure and New but also Welsh and **Organic**- see the **Organic** Materials page.

## Cover

All **alphabeds** mattress covers are 100% cotton . **Tenby** and **Brecon** mattresses have a traditional black and white stripe pattern (with fire retardant)

**Whitecroft** has a natural heavyweight herringbone weave cotton cover. All other mattresses have a heavyweight herringbone weave Natural Cotton cover. This is a natural shade fabric, woven to **alphabeds** specifications.

## Tufting

The best quality mattresses are always tufted: a tuft is a woven tape with a soft button at each end. This passes through the mattress and locks the layers of fillings together. **Alphabeds** mattresses are hand tufted for long life and stability.

## Firmness

Firmness of mattresses is very much a matter of personal choice.

**Alphabeds** mattresses are available in two or three grades of firmness, depending on core type. For advice on firmness, speak to a salesperson—but the best way to decide is to try them yourself in our showroom: don't be shy: take your time, there's no rush.

## Chemical Fire Retardants

Due to the thick layer of pure wool and the heavyweight cover, mattresses marked \* have no added fire retardant chemicals.

All mattresses conform to BS7177 Fire Safety Standard.

Name	Core Type	Firmness	Filings	Cover	2'6" /3' x 6'3"	3'6" x 6'3"	4'0" x 6'3"	4'6" x 6'3"	5'0" x 6'6"	5'6" x 6'6"	6'0" x 6'6"	Comment
<b>Tenby</b>	Open Spring	Firm & Extra Firm	Polyester	B&W stripe Cotton	£121	£187	£209	£242	£303	£380	£429	Open Spring Mixed Fibres
<b>Whitecroft*</b>	Open Spring	Firm & Extra Firm	Cotton/ Organic wool	Natural Unbleached Cotton	£253	£341	£374	£396	£429	£484	£539	Open Spring All Natural Filling
<b>Brecon</b>	Pocket Spring	Standard & Firm	Polyester	B&W Stripe Cotton	£286	£363	£479	£528	£594	£710	£765	Mixed Fibres
<b>Pembroke*</b>	Pocket Spring	Standard & Firm	Cotton/ Organic wool	Natural Unbleached Cotton	£413	£479	£599	£660	£715	£853	£913	Natural/ Organic Fillings
<b>Monmouth*</b>	Pocket Spring	Standard & Firm	Organic wool	Natural Unbleached Cotton	£468	£561	£649	£737	£803	£924	£979	Organic Fillings
<b>Cambria*</b> (all 6'6" length)	Coir/Latex	Firm+	Organic wool	Natural Unbleached cotton	£680	£760	£900	£960	£1060	£1275	£1375	Metal Free. All Natural
<b>Wrexham*</b> (all 6'6" length)	Latex	Firm	Organic wool	Natural Unbleached Cotton	£680	£760	£900	£960	£1060	£1275	£1375	Organic Fillings
<b>Raglan* 3+2</b>	Cotton 3 layers	Firm	Cotton/ Organic wool	Natural Unbleached Cotton	£184	£200	£215	£220	£258	£347	£368	Futon Style Mattress
<b>Raglan* 5+2</b>	Cotton 5 layers	Firm	Cotton/ Organic wool	Natural Unbleached Cotton	£205	£220	£236	£242	£278	£368	£410	Futon Style Mattress
<b>Futon 3 layers</b>	Cotton	Firm	Cotton	B&W Stripe Cotton	£95	£100	£105	£116	£126	£137	£147	
<b>Futon 5 layers</b>	Cotton	Firm	Cotton	B&W Stripe Cotton	£116	£121	£126	£137	£147	£158	£168	
<b>Removable spongeable mattress protectors</b>					£30	£35	£50	£50	£63	£70	£80	

# alphabeds

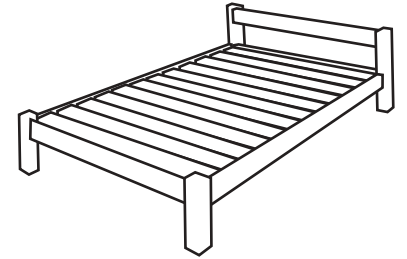
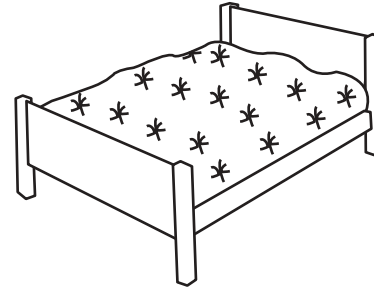
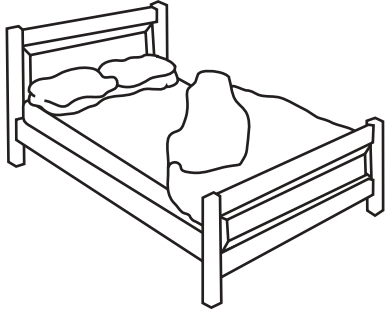

## organic plans & targets

**alphabeds** has always had an environmentally minded outlook. We have for several years incorporated alternative energy in our workshop using water power, bio-mass and combined heat and power techniques for energy saving and efficiency.

We were and are the only makers of a full range of mattresses to offer the choice of all natural materials with no added Fire Retardant chemicals (which still pass the legal requirements without any special certification needed by the customer).

In 2002 we decided to go one step further and design a range of **organic** mattresses. **Organic** mattresses are and have been available but usually as imports only and with a restricted range of sizes and types.

We can now offer mattresses made with **latex, coir** and **natural unbleached cotton covers**. And we are especially glad to be able to use **Welsh organic wool**: the produce of our near neighbours.